

B

C

E

公差表

REV	ECN NO	LOCATIONS	DESCRIPTION	DATE	CHANGER
A			新版本	2016-05-23	李国常

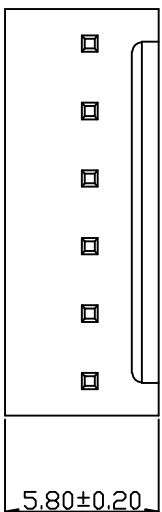

4

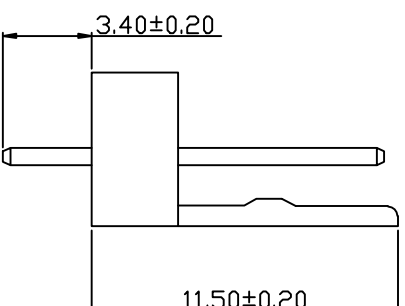
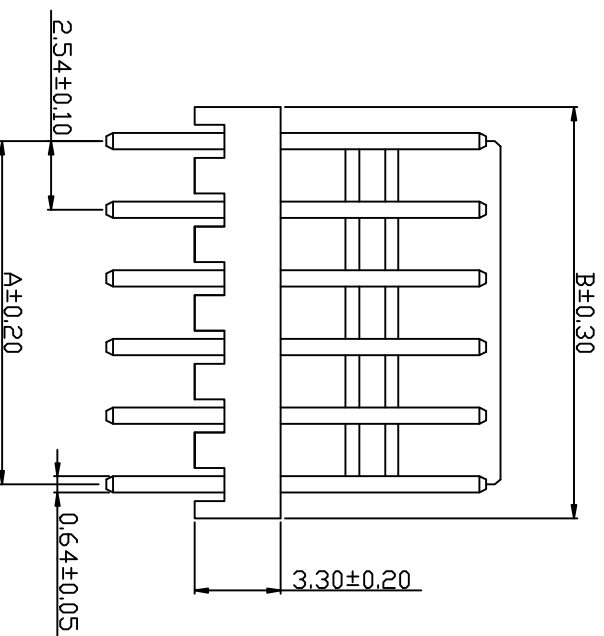

Part No	Dimensions (mm)	
	A	B
W2542V-02	2.54	5.08
W2542V-03	5.08	7.62
W2542V-04	7.62	10.16
W2542V-05	10.16	12.70
W2542V-06	12.70	15.24
W2542V-07	15.24	17.78
W2542V-08	17.78	20.32
W2542V-09	20.32	22.86
W2542V-10	22.86	25.40
W2542V-11	25.40	27.94
W2542V-12	27.94	30.48
W2542V-13	30.48	33.02
W2542V-14	33.02	35.56
W2542V-15	35.56	38.10
W2542V-16	38.10	40.64
W2542V-17	40.64	43.18
W2542V-18	43.18	45.72
W2542V-19	45.72	48.26
W2542V-20	48.26	50.80

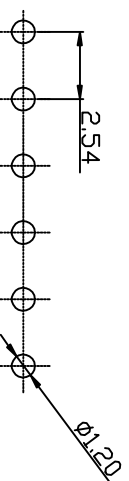

P.C.B LAYOUT

KLT 深圳市康利通电子科技有限公司

成品规格图

TOLERANCE

0±0.30

.0±0.25

.00±0.20

.000±0.015

TITLE	成品规格图		TOLERANCE	
CHECKED BY	DATE	SCALE	VER No	SIZE
	2016-05-23	1:1	A	A4

DRAWN BY	UNIT:mm			
李国常	PART No	W2542V-NP		

B

C

D

E

F

1

4

公差表

DESCRIPTION	DATE	CHANGER
版本	2016-05-23	李国常

50V AC, DC
A, AC, DC
Range: 1500V AC/minute
Ince: 1000MΩ min
e: -40C~+85C
ce: 20MΩ max

4

B

2016-05-23	
DRAWN BY	UNIT:mm
李国常	PART No
	W

B

C

▽

D

E

4

B

C

E

公差表

REV	ECN NO	LOCATIONS	DESCRIPTION	DATE	CHANGER
A			新版本	2016-05-23	李国常

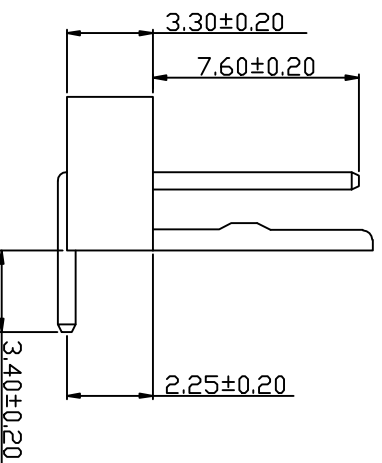
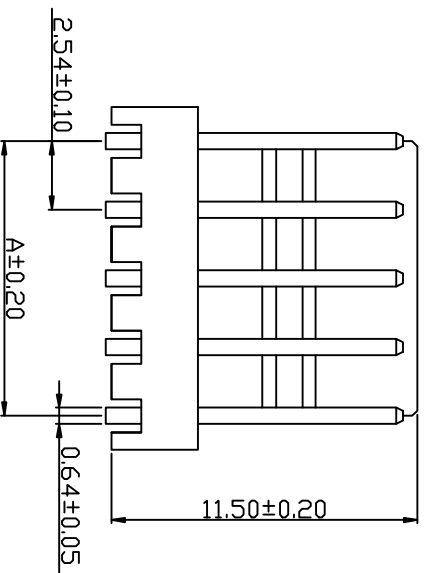
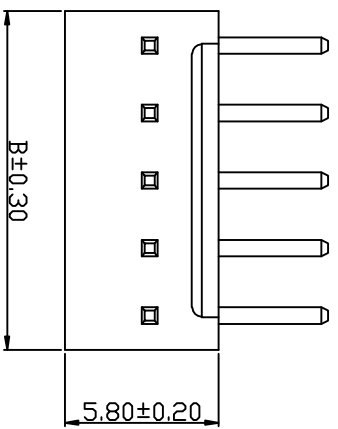

TYPE 1

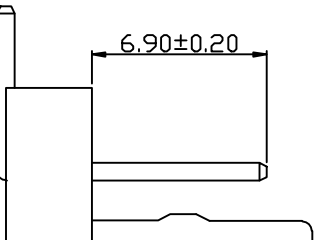

TYPE 2

Part No	Dimensions (mm)	
	A	B
V2542R-02	2.54	5.08
V2542R-03	5.08	7.62
V2542R-04	7.62	10.16
V2542R-05	10.16	12.70
V2542R-06	12.70	15.24
V2542R-07	15.24	17.78
V2542R-08	17.78	20.32
V2542R-09	20.32	22.86
V2542R-10	22.86	25.40
V2542R-11	25.40	27.94
V2542R-12	27.94	30.48
V2542R-13	30.48	33.02
V2542R-14	33.02	35.56
V2542R-15	35.56	38.10
V2542R-16	38.10	40.64
V2542R-17	40.64	43.18
V2542R-18	43.18	45.72
V2542R-19	45.72	48.26
V2542R-20	48.26	50.80

- SPECIFICATIONS**
- Voltage rating: 250V AC, DC
 - Current rating: 3A, AC, DC
 - Withstanding Voltage: 1500V AC/minute
 - Insulation resistance: 1000MΩ min
 - Temperature range: -40°C~+85°C
 - Contact resistance: 20MΩ max
- WAFER
- Part No: W2542R-NP
 - Poles: 02-20
 - Material: Nylon 66 UL94V-2
 - Pin Material: Brass /Tin-plated

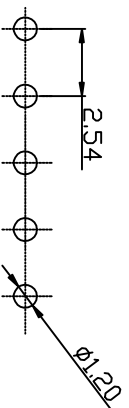

P.C.B LAYOUT

KLT 深圳市康利通电子科技有限公司

成品规格图

TOLERANCE

0±0.30

.0±0.25

.00±0.20

.000±0.015

VER No SIZE

A A4

TITLE	成品规格图		SCALE		1:1	VER No	SIZE
CHECKED BY	DATE	2016-05-23	SCALE	1:1	VER No	SIZE	
DRAWN BY	UNIT:mm				A	A4	
李国常	PART No	W2542R-NP					

4

4

B

C

D

E

F

1

B

C

D