

B

C

E

公差表

REV	ECN NO	LOCATIONS	DESCRIPTION	DATE	CHANGER
A			新版本	2017-12-13	李国常

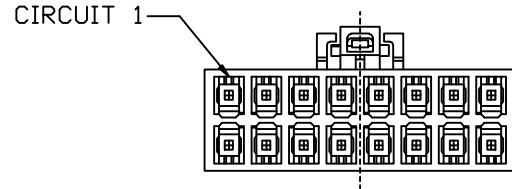
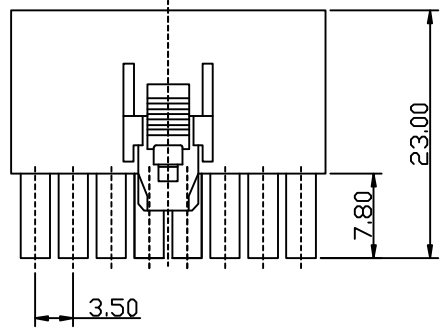

SPECIFICATIONS:

1. Current Rating: 14A, AC/DC Max
2. Voltage Rating: 400V AC/DC
3. Contact Resistance: 10mΩ Max
4. Insulation Resistance: 1000MΩ min
5. Withstanding Voltage: 1800V AC/Minute
6. Temperature Range: -40°C~+105°C
7. Material: Nylon 66 UL94V-0
8. Mate with: H3501H Series Wafer
9. Recommended Insulator:
  - 16AWG WIRE -OD 2.00mm Max
  - 18AWG WIRE -OD 1.70mm Max
  - 20AWG WIRE -OD 1.50mm Max
  - 22AWG WIRE -OD 1.20mm Max

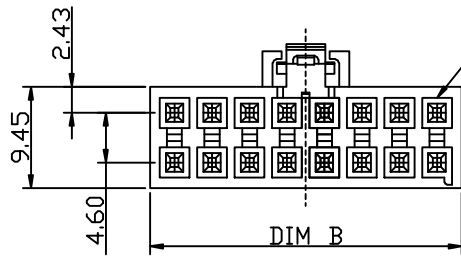

CIRCUIT 1

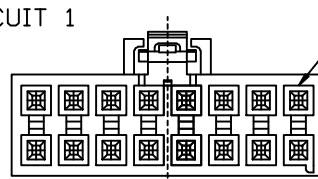

TPA OPTION-BLACK COLOR (KEY A)

CIRCUIT 1

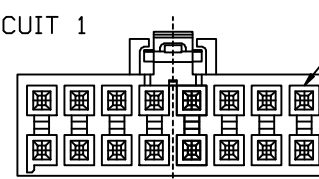

TPA OPTION-NATURAL COLOR (KEY B)

CIRCUIT 1

WITH TPA ATTACH FEATURE					
PART NO.	UL	COLOR	CIRCUIT SIZE	KEY OPTION	DIM B
H3501H-202-A1-B	V-0	BLACK	2	KEY A	8.00
H3501H-203-A1-B	V-0	BLACK	3	KEY A	11.50
H3501H-204-A1-B	V-0	BLACK	4	KEY A	15.00
H3501H-205-A1-B	V-0	BLACK	5	KEY A	18.50
H3501H-206-A1-B	V-0	BLACK	6	KEY A	22.00
H3501H-207-A1-B	V-0	BLACK	7	KEY A	25.50
H3501H-208-A1-B	V-0	BLACK	8	KEY A	29.00
H3501H-202-B1	V-0	NATURAL	2	KEY B	8.00
H3501H-203-B1	V-0	NATURAL	3	KEY B	11.50
H3501H-204-B1	V-0	NATURAL	4	KEY B	15.00
H3501H-205-B1	V-0	NATURAL	5	KEY B	18.50
H3501H-206-B1	V-0	NATURAL	6	KEY B	22.00
H3501H-207-B1	V-0	NATURAL	7	KEY B	25.50
H3501H-208-B1	V-0	NATURAL	8	KEY B	29.00

WITH TPA ATTACH FEATURE					
PART NO.	UL	COLOR	CIRCUIT SIZE	KEY OPTION	DIM B
H3501H-202-A2-B	V-0	BLACK	2	KEY A	8.00
H3501H-203-A2-B	V-0	BLACK	3	KEY A	11.50
H3501H-204-A2-B	V-0	BLACK	4	KEY A	15.00
H3501H-205-A2-B	V-0	BLACK	5	KEY A	18.50
H3501H-206-A2-B	V-0	BLACK	6	KEY A	22.00
H3501H-207-A2-B	V-0	BLACK	7	KEY A	25.50
H3501H-208-A2-B	V-0	BLACK	8	KEY A	29.00
H3501H-202-B2	V-0	NATURAL	2	KEY B	8.00
H3501H-203-B2	V-0	NATURAL	3	KEY B	11.50
H3501H-204-B2	V-0	NATURAL	4	KEY B	15.00
H3501H-205-B2	V-0	NATURAL	5	KEY B	18.50
H3501H-206-B2	V-0	NATURAL	6	KEY B	22.00
H3501H-207-B2	V-0	NATURAL	7	KEY B	25.50
H3501H-208-B2	V-0	NATURAL	8	KEY B	29.00

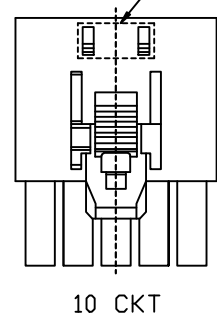
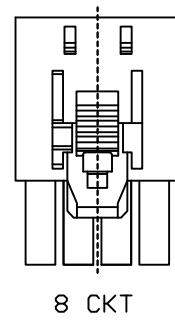
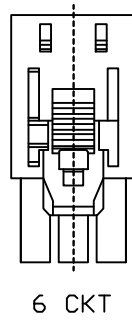
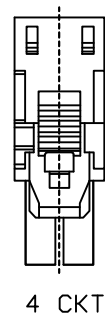

TPA FEATURE BOTH SIDES

TPA FEATURE BOTH SIDES

TPA LATCH OPTION

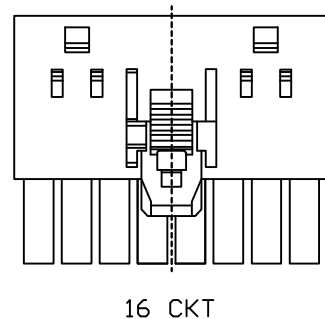
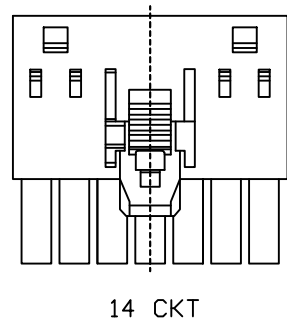
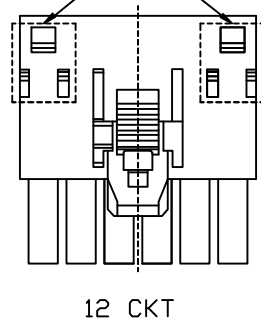

深圳市康利通电子科技有限公司 TITLE 成品规格图 CHECKED BY DATE 2017-12-13 SCALE 1:1 DRAWN BY 李国常 UNIT:mm PART No H3501H-2XX-XX			TOLERANCE		
			0±0.30		
			.0±0.25		
			.00±0.20		
		.000±0.015		VER No	SIZE
				A	A4

B

C

D

E

F