

版次: 1.0

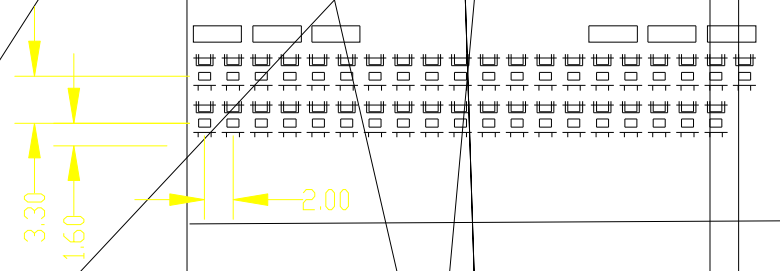

- 1 . MATERIAL: GLASS FILED THERMO PLASTIC POLYESTER(94V-0), COLOR: BLACK
- 2 . THE SHAPE, SIZE AND POSITION OF THE CHARACTER SHOW THE OUTLINE. THEY DON'T SHOW DETAILS.
- 3 . DIFFERENT HEIGHT OF LOCK PROTECTOR. A FINGERTIP IS STOOD AND PUSHED WHEN OPERATING A LOCK LEVER

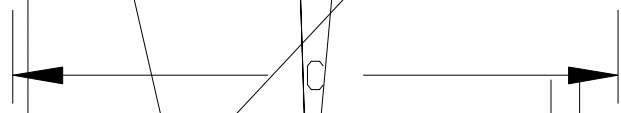
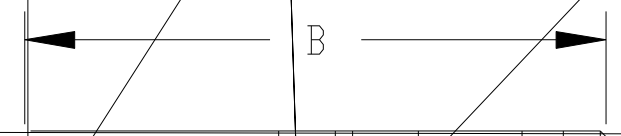
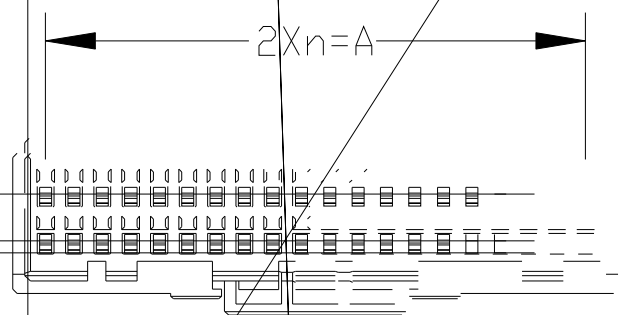
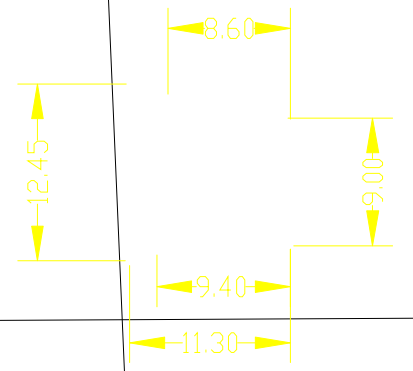

| POS | n | A | B | C | KEY | PA |
|-----|----|------|------|------|-----|-------------------|
| 10P | 4 | 8.0 | 10.9 | 12.6 | | KF 7020-0510-2.0P |
| 20P | | 18.0 | 20.9 | 22.6 | | KF 7020-1020-2.0P |
| 22P | 10 | 20.0 | 22.9 | 24.6 | X | KF 7020-1122-2.0P |
| 26P | 12 | 24.0 | 26.9 | 28.6 | X | KF 7020-1326-2.0P |
| 28P | 13 | 26.0 | 28.9 | 30.6 | X | KF 7020-1428-2.0P |
| 30P | 14 | 28.0 | 30.9 | 32.6 | | KF 7020-1530-2.0P |
| 32P | 15 | 30.0 | 32.9 | 34.6 | X | KF 7020-1632-2.0P |
| 34P | 16 | 32.0 | 34.9 | 36.6 | X | KF 7020-1734-2.0P |
| 40P | 19 | 38.0 | 40.9 | 42.6 | X | KF 7020-2040-2.0P |

| | | | | | |
|----------------|---------|-------|-----|-------|-------------------|
| 设计 | 李国常 | 序号 | 数量 | 材料 | 颜色 |
| 校对 | | | | PA-GF | 黑色 |
| 审定 | 林振华 | | | | |
| 客户型号 | | | | | |
| 第三角画法 | 标记 | 更改前数值 | 标记 | 更改前数值 | 更改日期 |
| 产品材料/颜色 | 产品名称 | 胶壳 | | 产品型号 | KF 7020-2040-2.0P |
| 深圳市康利通电子科技有限公司 | 阶段标记 | B | | 图纸编号 | |
| | 共1页 第1页 | 比例 | 1:1 | 单位 | mm |
| | | | | 设计日期 | 2019-01-03 |

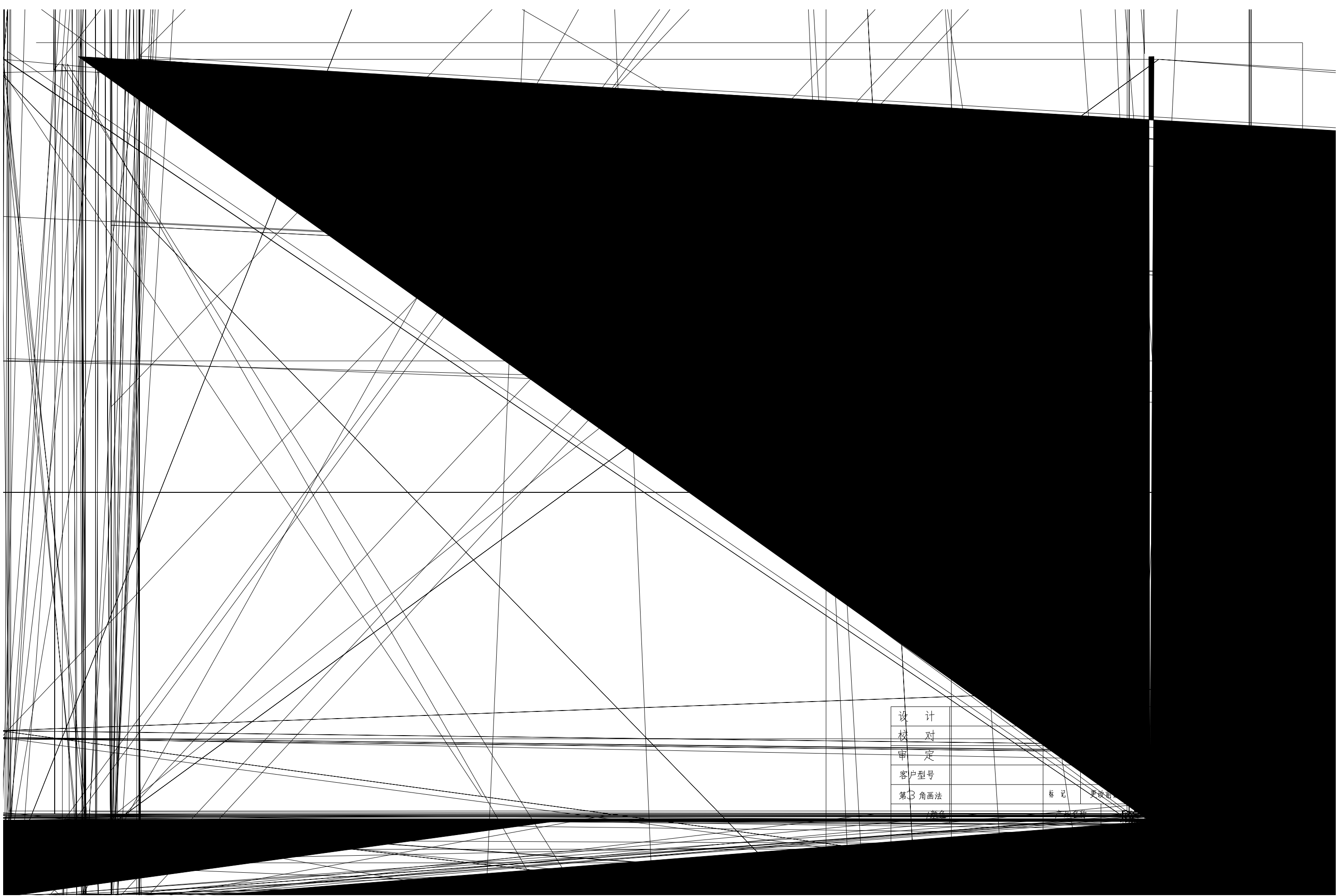

| | | | |
|-------|--|----|-----|
| 设计 | | | |
| 校对 | | | |
| 审定 | | | |
| 客户型号 | | | |
| 第3角画法 | | 标记 | 更改前 |

版次: 1.0

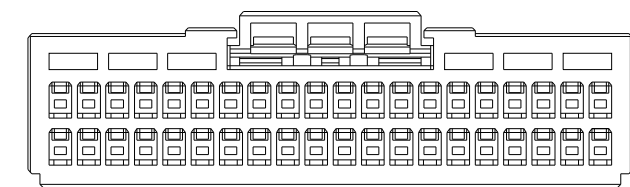
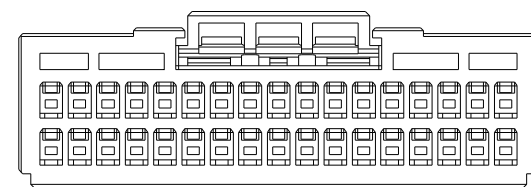
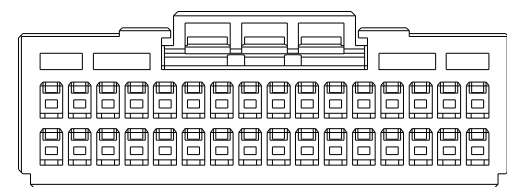
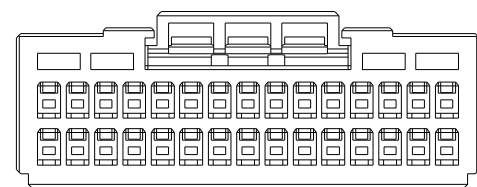
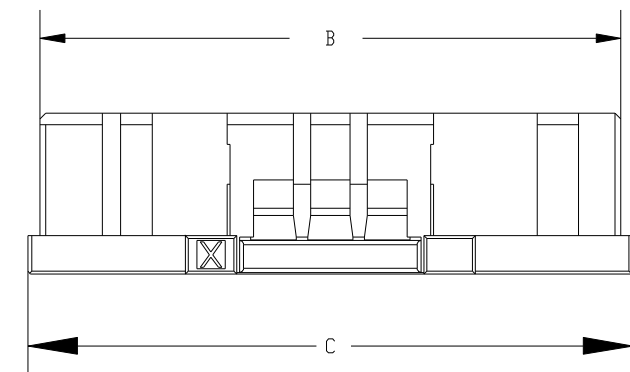
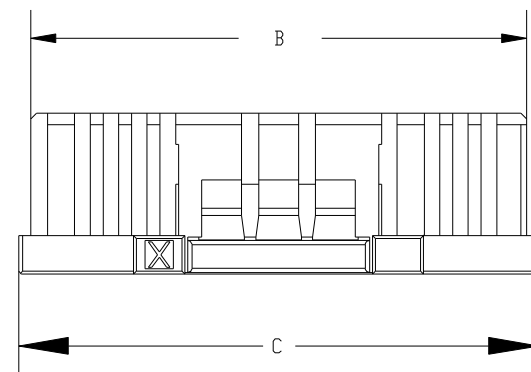
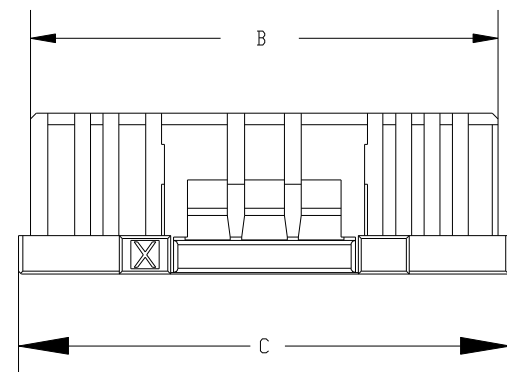
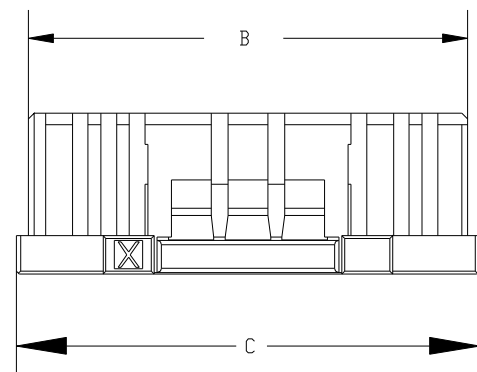
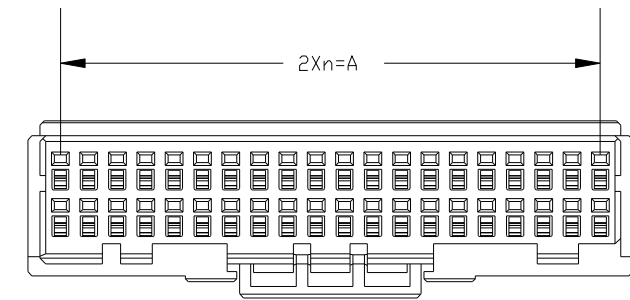
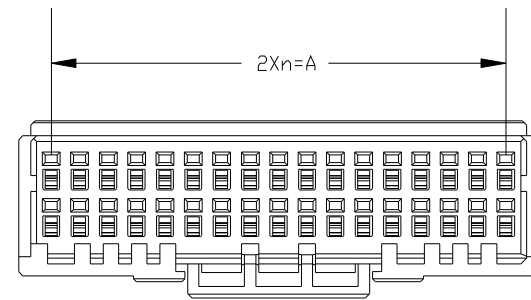
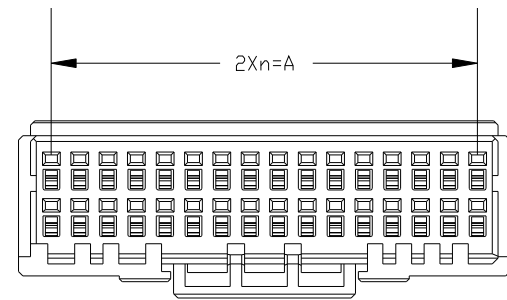
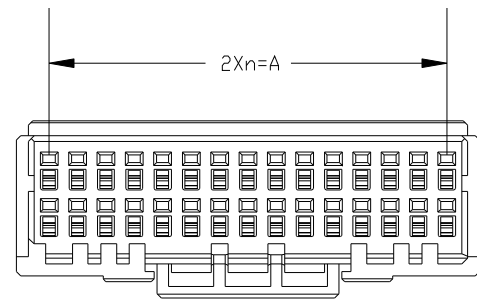

KF 7020-1530-2.0P

KF 7020-1632-2.0P

KF 7020-1734-2.0P

KF 7020-2040-2.0P

| | | | | | |
|----------------|------------|-------|----|-------|-------------------|
| 设计 | 李国常 | 序号 | 数量 | 材料 | 颜色 |
| 校对 | | | | PA-GF | 黑色 |
| 审定 | 林振华 | | | | |
| 客户型号 | | | | | |
| 第三角画法 | 标记 | 更改前数值 | 标记 | 更改前数值 | 更改日期 |
| 产品材料/颜色 | 产品名称 | 胶壳 | | 产品型号 | KF 7020-XXXX-2.0P |
| 深圳市康利通电子科技有限公司 | 阶段标记 | B | | 图纸编号 | |
| | 共1页 第1页 比例 | 1:1 | 单位 | mm | 设计日期 2019-01-03 |